

The Tube Heater Principle

Innovative and Energy-saving Industrial Heating

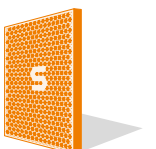

Schwank
INNOVATIVE HEATING SOLUTIONS



Innovative and Energy-saving Industrial Heating

■ The tube heater technology

Radiant tube heaters are gas-fired infrared heating devices and rank among the group of decentralised heating systems. As opposed to central heating systems, they are characterised by the fact that their heat is precisely generated at the place where it is needed [warehouse, workplace, production etc.]. A radiant tube heater outputs infrared radiation via its long dark radiant tubes.



■ Design and characteristics

A burner generates a long laminar flame inside the radiant tube. This flame heats the radiant tubes up to a max. temperature of 580°C. An exhaust system mounted at the end of the tube heater discharges the combustion exhaust gas to atmosphere. The reflectors located above the radiant tubes guide the infrared rays to the occupancy level. Additionally by insulating the reflectors the loss of heat energy through the reflector is reduced along with convection heat building up below the building's ceiling. In this way, heat is transferred precisely to where it is required – the occupancy level.

Gas-fired infrared tube heater



Tube Heaters in L-Shape and U-Shape

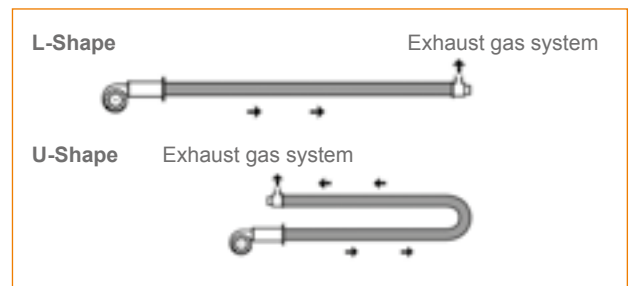

Market Leader in Matters of Quality and Innovation

■ Tube heaters – “Made in Germany”

Radiant tube heaters “Made in Germany” by Schwank excel at providing innovative detail solutions and are built to outstanding quality standards. The materials used have been carefully selected with regard to long life and preserving value. The core of the Schwank tube heaters is the Whisper-Jet burner. With its burner plate – designed and manufactured by Schwank [patented] – it generates up to a 5m long laminar flame.

State-of-the-art tube heaters utilise a fan burner [also called forced-air fan]. This grants maximum reliability and provides fail-safety of the mechanically moving parts and electrical components. The Whisper-Jet burner represents the latest state-of-the-art burner technology and has been optimised for a low-pollutant and eco-friendly combustion of the air-gas mixture. It can be fired by natural gas, LPG or bio gas.

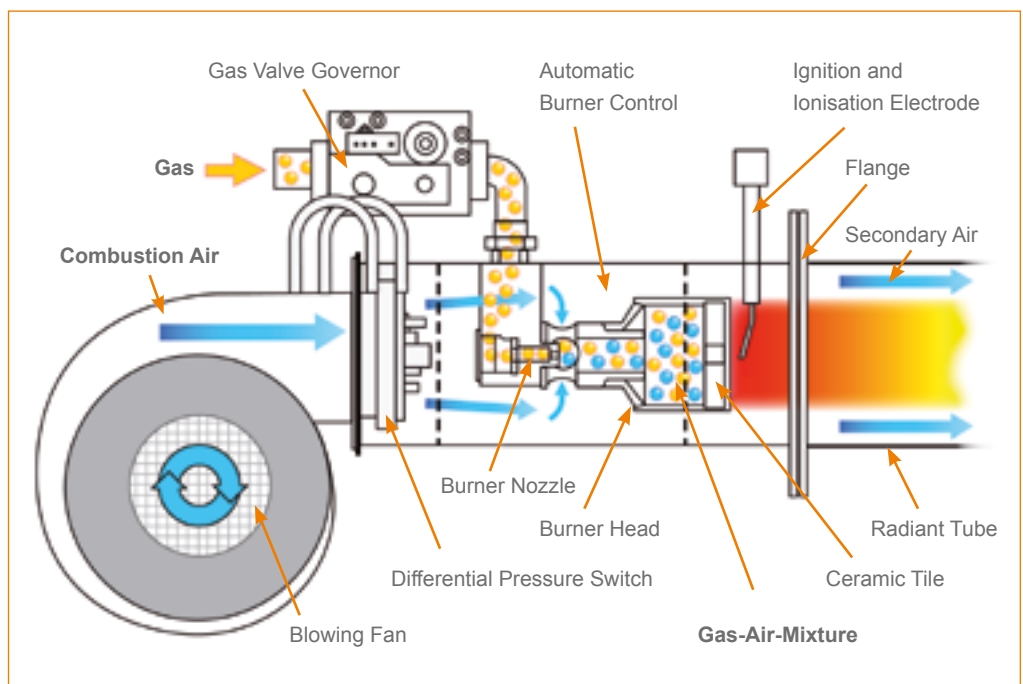

Whisper-Jet burner
With the patented Schwank ceramic tile

The Active Principle

■ Minimise energy loss

The energy loss of radiant tube heaters with non-insulated reflectors is considerable, as a significant amount of convection and radiation heat is generated on the surface of the reflectors which accumulates under the building's ceiling and is thus wasted. Taken altogether, this is reflected in radiation factors [device efficiency] of approx. 50 to 60%. Using the example of the most energy efficient Schwank radiant tube heaters [superTube®], it becomes quickly apparent how energy savings may be realised as early as the system design phase.

Furthermore, well proven calorised radiant tubes are used with all Schwank tube heaters offering an emission degree of approx. 95%. Reflectors with duplicate insulation additionally enhance the efficiency of the tube heater. Hardly any energy is lost due to hot air stratification. All these are constructive measures which pay off in the end: They make the radiation factor [device efficiency] rise up to 77.5%* and thus radiant tube heaters by Schwank rank among the best of the best worldwide.

* Radiant factor of superTube® 630 measured by DVGW laboratory according to DIN EN 416-2

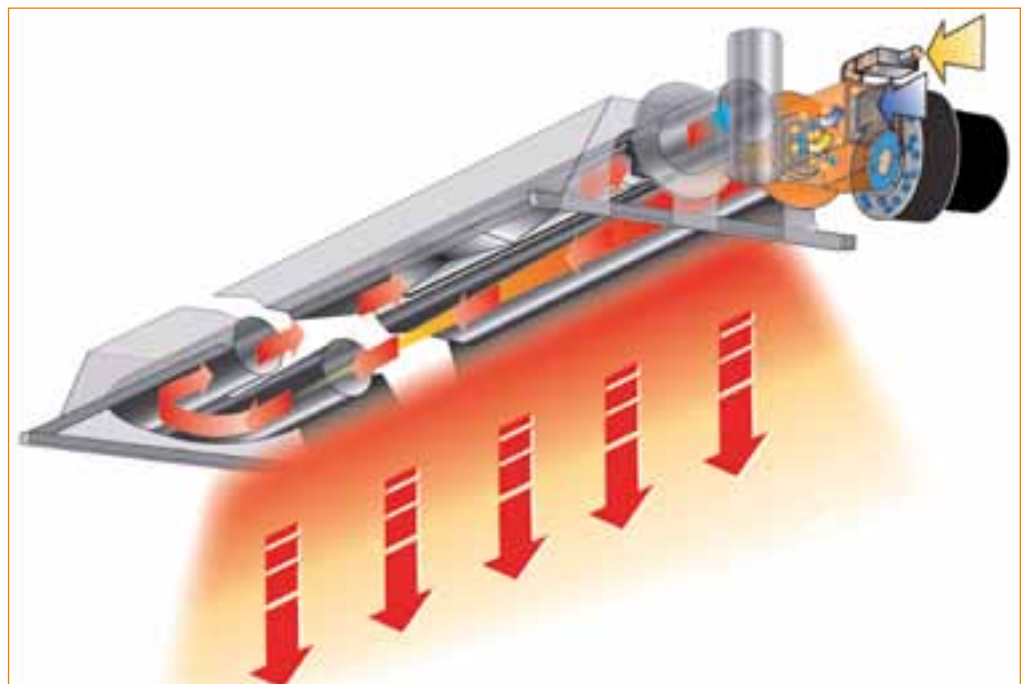

The active principle of a Schwank tube heater

Advantages at a Glance

■ Burner “Whisper-Jet”

- Forced-air fan for maximum fail-safety, no temperature exposure of bearings and electronic components
- Ceramic burner plate for uniform heat distribution
- Long laminar flame for uniform heat distribution inside the radiant tube
- Operation as quiet as a whisper
- 1-stage, 2-stage or fully modulating control operating modes

■ Reflector material and design

- Radiation-optimised reflector geometry
- Reflection optimised material [reflection degree up to 95%]
- Special heat resistant and highly efficient reflector insulation [for superTube and calorSchwank only] to minimise convection and radiation loss through hot air stratification below the ceiling



■ Calorised radiant tubes

- Emission degree of up to 95%
- Low linear expansion – material preserving function
- Permanently corrosion-resistant
- Stainless steel turbulators for increasing the heat transfer [flame to radiant tube]

■ Radiation factor / device efficiency

- Simple entry level products up to high-end systems counted among the best in the world with their radiation factor of up to 77.5 %*
- Compared to standard products, up to 32% energy costs may be saved

■ Individual exhaust and air supply systems

- Direct or indirect exhaust gas routing
- Exhaust gas routing with or without preheating of the combustion air [concentric system]
- Single exhaust gas system
- Collective exhaust gas system

■ Heat recovery

- Optional connection to heat recovery hybridSchwank
- Recovery of up to 15% of the installed heating power up to max. 108% total output

* Radiant factor of superTube® 630 measured by DVGW laboratory according to DIN EN 416-2

Product Variety by Schwank

■ The matching technology for each application

Play it safe with radiant tube heaters by Schwank. Schwank offers the most appropriate heating system for each individual application.

Schwank radiant tube heaters are available in four categories: From the low priced entry level product up to the high-end product.



Features	novoSchwank [basic]	infraSchwank [standard]	calorSchwank [premium]	superTube [premium plus]
Power types	15, 20, 30, 40, 50	15, 20, 30, 40, 50, 60, 100, 120	15, 20, 30, 40, 50, 60, 100, 120	15, 20, 25, 30, 40, 50
Length	3.582 - 14.090 mm	3.582 - 20.430 mm	3.582 - 20.430 mm	3.760 - 9.680 mm
Whisper-Jet Burner	✓	✓	✓	✓
Patented ceramic burner tile	✓	✓	✓	✓
L- and U-Shape	✓	✓	✓	only U
Connection to building management technology	✓	✓	✓	✓
Turbulator	-	✓	✓	✓
2-stage or fully modulating operation	-	✓	✓	✓
Fully insulated reflector	-	-	✓	✓
Duo-Insulation	-	-	-	✓
Feran-Reflector	-	-	-	✓
Optional colours	-	-	-	✓
Heat recovery system	✓	✓	✓	✓
Thermal efficiency	< 93%	< 93%	< 93%	< 93%
Radiation factor	52,0%*	59,3%*	70,2%*	77,5%*

*Radiant factor measured by DVGW laboratory according to DIN EN 416-2

Individual Solutions for Your Heating Demands

■ Fields of application

Individual applications and building structures require individual solutions. More than 150,000 customers worldwide value this large variety for their heating requirements.

From industrial or distribution facilities and warehouses up to hangars, railway stations or sports facilities. Schwank heaters can be found in the most varied applications.



Exhaust gas systems

- The Schwank radiant tube heaters essentially offer 2 different solutions for the air/exhaust gas systems

Single exhaust gas system
[individual per heater]
with or without external
combustion air supply

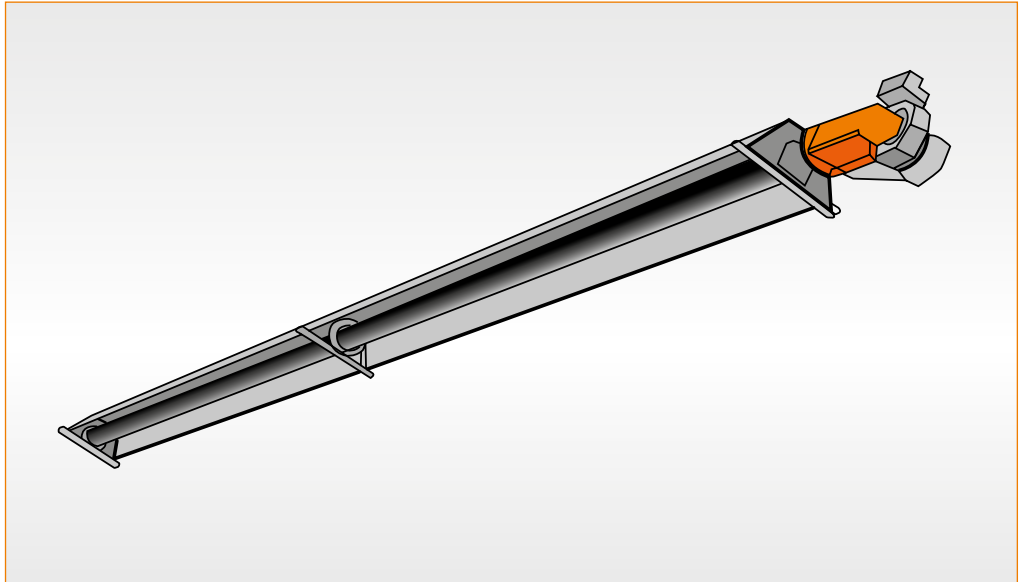

Collective exhaust gas system and central exhaust gas ventilator
[for several tube heaters]

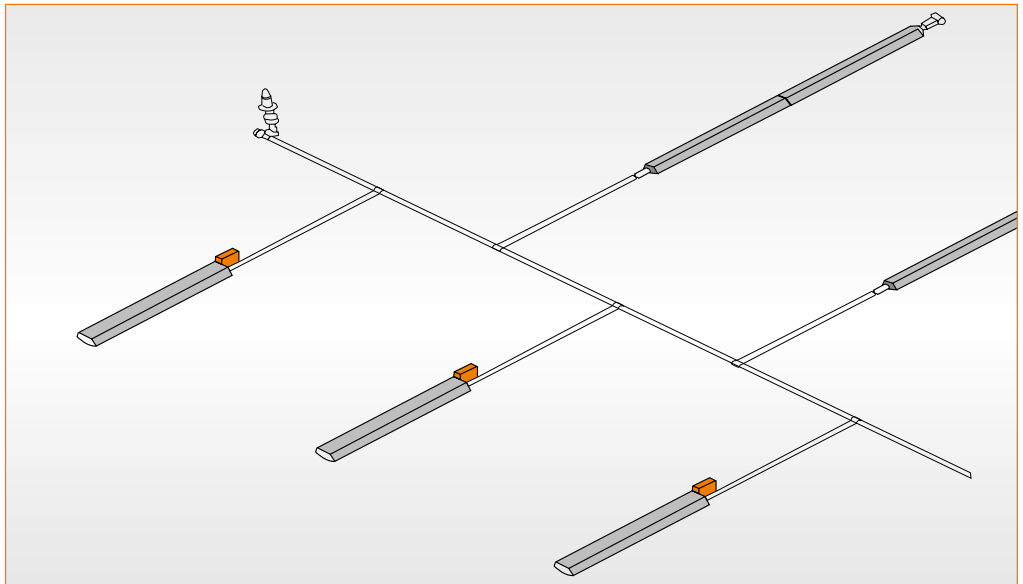

Tailor-made Consulting

■ Project design

What is important is the uniform heat emission in the area to be heated. An uneven distribution leads to zones with low temperatures, similar to „shadows“ in illumination engineering. This may make sense in some cases [storage space], but must be avoided if uniform heating is to be achieved. Our experts will be happy to provide support in planning your individual heating solution. Roughly, the design may be executed as follows:

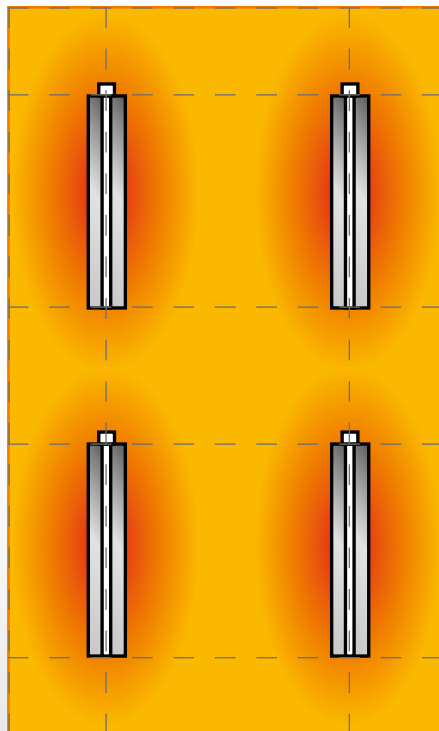
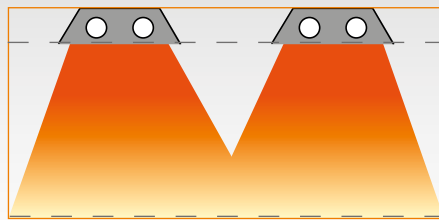

Example:
Schwank Tube Heaters
in a Horizontal Set-up

Energy flow charts of Schwank tube heaters

superTube

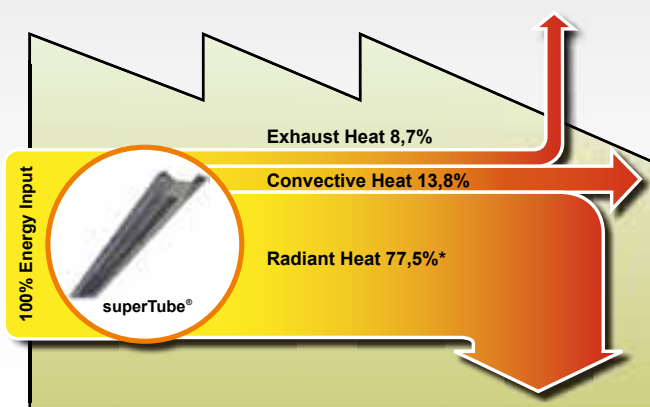

* Radiant factor of superTube® 630 measured by DVGW laboratory according to DIN EN 416-2

calorSchwank

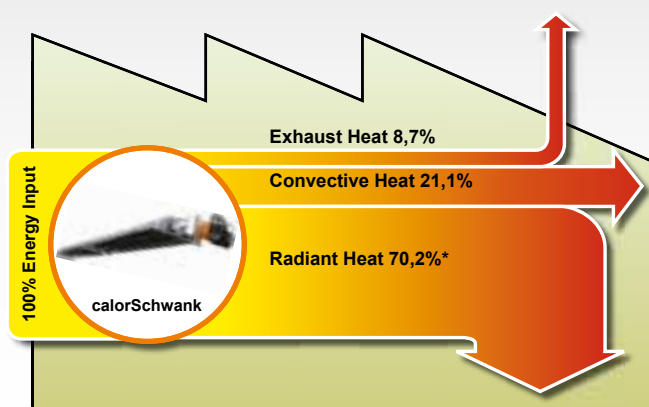

* Radiant factor of calorSchwank 30U measured by DVGW laboratory according to DIN EN 416-2

infraSchwank

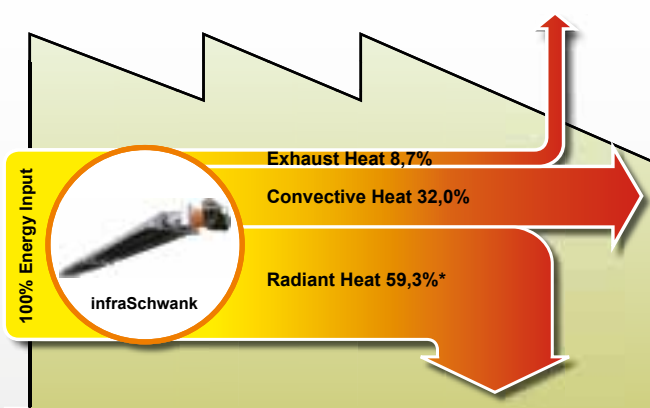

* Radiant factor of infraSchwank 30U measured by DVGW laboratory according to DIN EN 416-2

novoSchwank

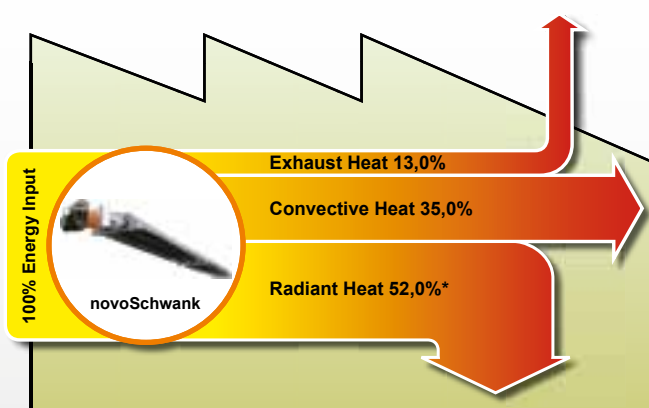

* Radiant factor of novoSchwank 30U measured by DVGW laboratory according to DIN EN 416-2

Important terms for infrared heaters

How is the efficiency of a gas-fired infrared heater measured? What does radiation intensity mean and what is thermal system efficiency? Please read the answers to frequently asked questions below:

■ Thermal efficiency:

The ratio between the input power and the output power remaining inside the building. Energy losses through exhaust gas are the only factor analysed here. All infrared heaters have a thermal efficiency of up to 93% [tube heaters] or 95% [luminous heaters].

■ Radiation factor, also device efficiency:

Reflects the share of the energy converted into radiant heat in relationship to the input power inside the occupied or utility area. The higher this value, the better the energy efficiency of the infrared heater and the lower the energy costs. Especially on this point, devices differ considerably. Commercial tube heaters start at approx. 50%, while Schwank tube heaters offer a radiation factor of up to 77.5% [measured by DVGW test laboratory on the heater type superTube 630 in accordance with DIN EN 416-2]. This is proven by a test certificate of the DBI [certified test institute] and its conformity with standard DIN EN 416-2.

■ Convection heat:

Convection heat is generated by air heating up at warm surfaces. In the case of infrared heaters, it is primarily generated by heated reflectors. However, if the reflectors are well insulated, the share of convection heat is reduced producing more radiation heat.

■ Radiation temperature / radiation intensity:

The temperature value which represents the infrared radiation. Here, the radiation intensity is measured in W/m^2 and converted to $^{\circ}C$ by multiplication with e.g. the Bedford factor. The radiation temperature may be calculated before the system installation or following the installation using special measuring sensors.

■ Room temperature / comfort temperature:

The temperature felt by people. Essentially, it is composed of the air temperature and the radiation temperature in equal shares.

Innovative. Experienced. Competent.

■ Experience for more safety

For more than 70 years, the name Schwank has stood for high-quality and cost-efficient building heating systems. As the market leader for gas-fired infrared heaters, Schwank has comprehensive experience in using cost-efficient heating systems. More than 150,000 satisfied customers and over 2 million appliances produced speak for themselves [for reference, see www.schwank.de].

As a German manufacturer, we aspire to a high standard of excellence in delivering products and service of the highest quality. Each single Schwank product excels by adopting economic procedures with minimum CO₂ emission.



United Kingdom

Schwank Ltd
62 Sunningdale Road
Sutton, Surrey SM1 2JS
Tel.: +44 (0) 208 641 3900
Fax: +44 (0) 208 641 2594
E-mail: sales@schwank.co.uk
Internet: www.schwank.co.uk

Ireland

Eurogas Ltd
Unit 38B, Southern Cross
Bus Pk, Boghall Road
Bray, Co Wicklow
Tel.: +353 1 286 8244
Fax: +353 1 286 1729
E-mail: info@eurogas.ie
Internet: www.eurogas.ie

Australia

Devex Systems Pty Limited
5/83 Bassett St
Mona Vale NSW 2103
Tel.: +61 02 9997 2811
Fax: +61 02 9997 7852
E-mail: info@devexsystems.com.au
Internet: www.schwank.com.au

New Zealand

Energy Products Int.
30 Gallagher Drive,
Frankton, Hamilton
Tel.: +64 7 839 2705
Fax: +64 7 834 4212
E-mail: sales@energy-products.co.nz
Internet: www.energy-products.co.nz

